

- Item: Dielectric Patch Antenna Element for GPS L1 Band
- Part Number: ANPS1575G4Z XX



■ Electric Specification

ITEM	SPECIFICATION	UNIT	CONDITIONS
Outline Dimension	35x17x4	mm	
Center frequency	1575.42	MHz	@58x19mm Ground Plane
Bandwidth	10	MHz typ.	@ V.S.W.R 2.0:1
Gain at Zenith	+1.7	dBic typ.	@58x19mm Ground Plane
Axial Ratio	7.0	dB typ.	@Center frequency
Impedance	50	Ω	
Polarization	RHCP		
TemperatureCoefficient	20	ppm/°C	-40°C to +85°C

■ Dimension

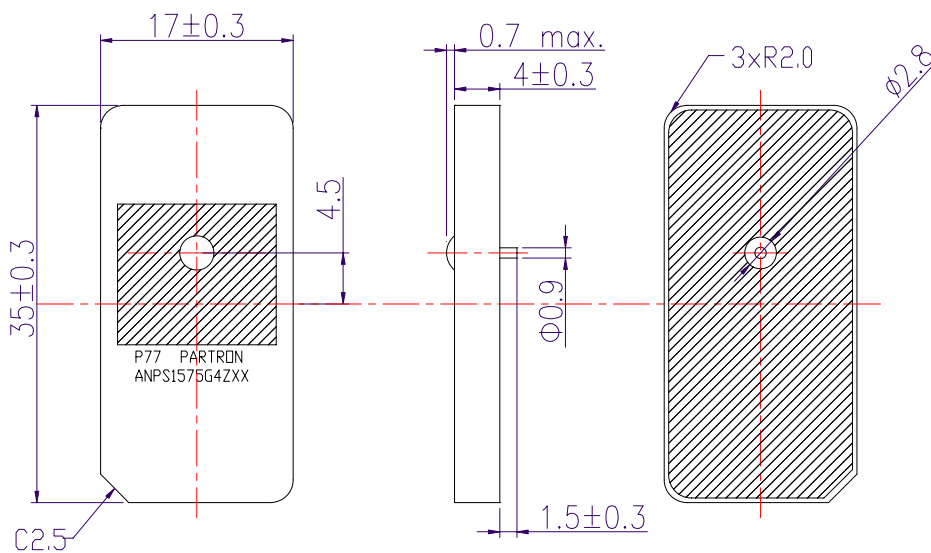

Unit: mm

■ Typical Characteristics

-Smith Chart & V.S.W.R.

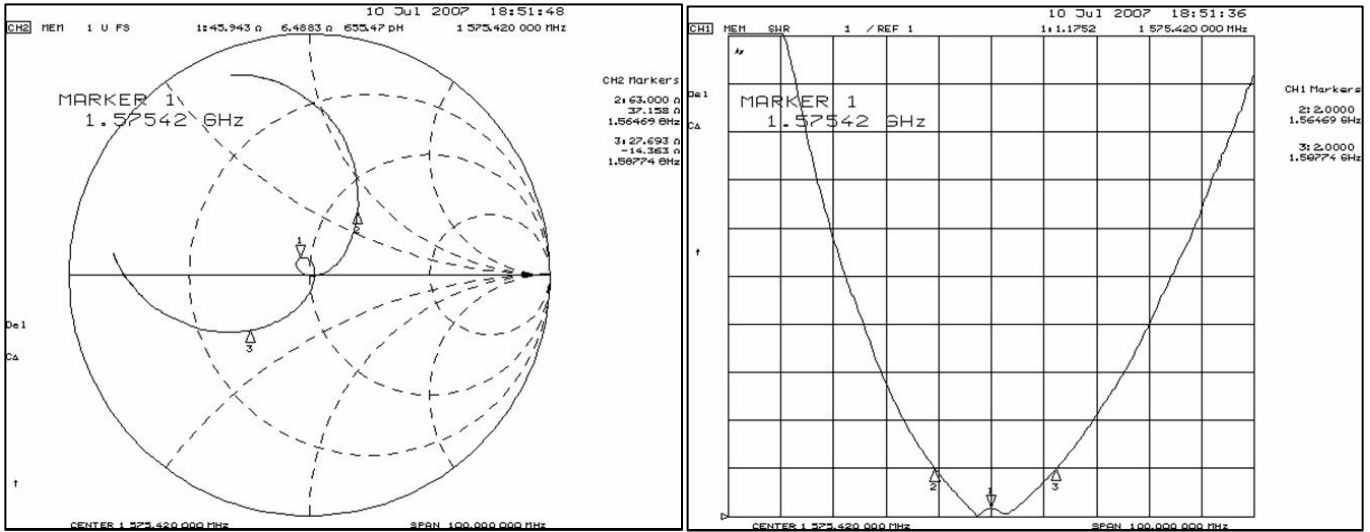

-Radiation Pattern

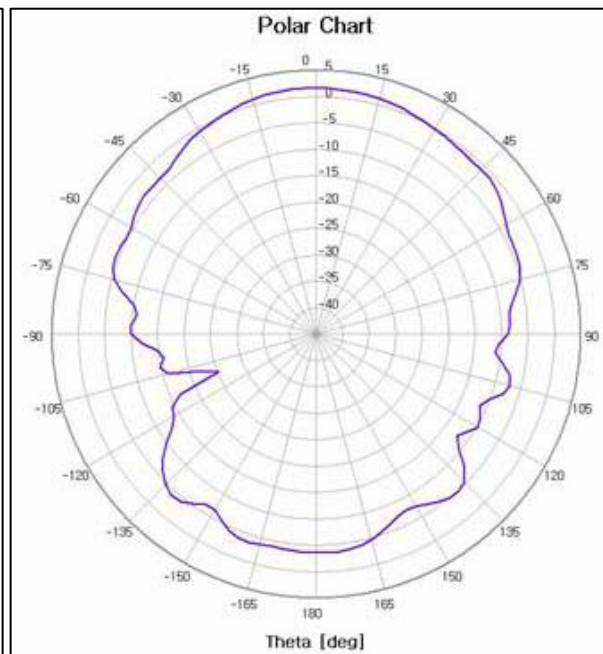
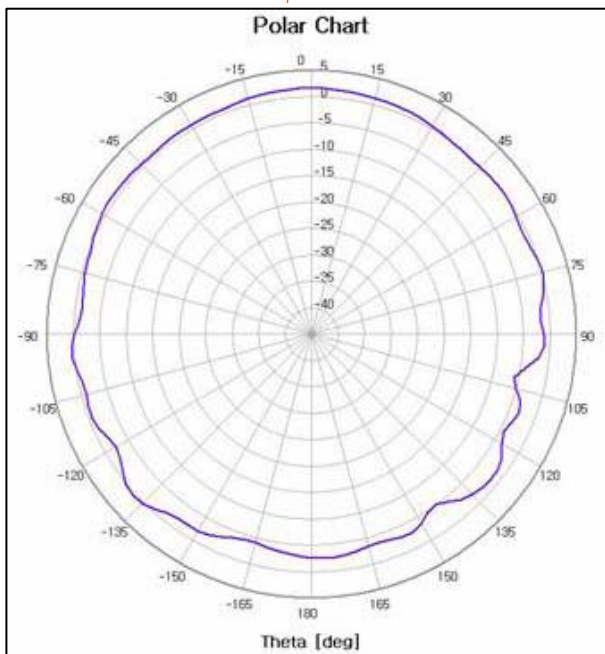
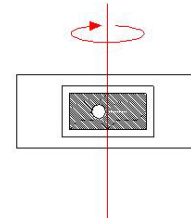
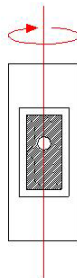

■ Measurement condition

S-parameter and V.S.W.R. (Return Loss) measurement

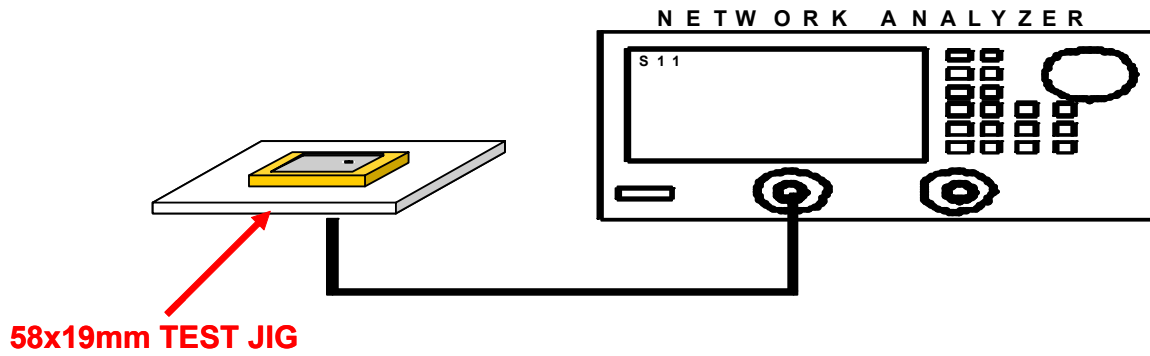

Gain measurement

